

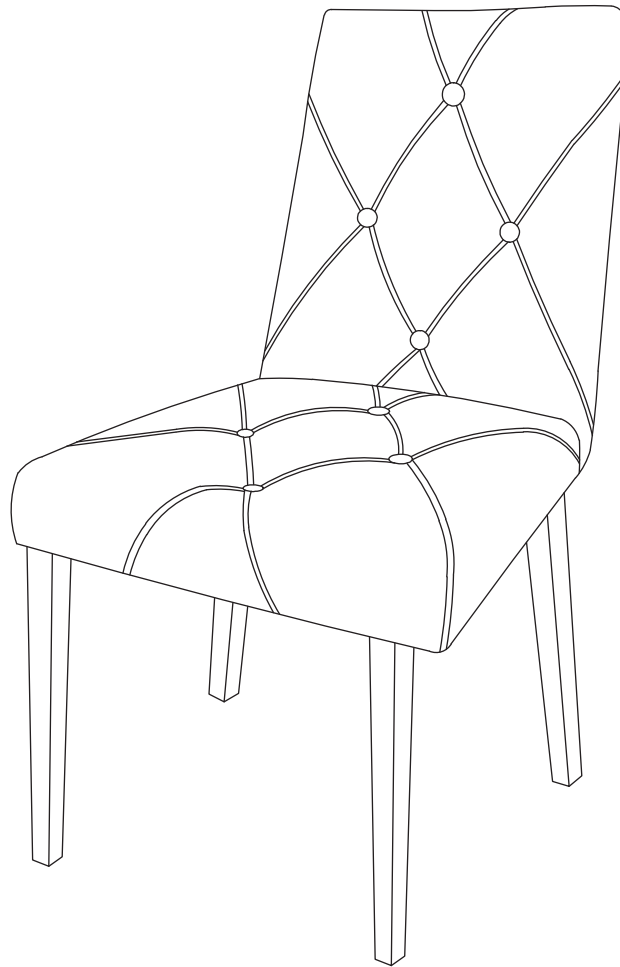

ELLA+ROSS

# Assembly Instructions



# ANTALYA





Dining Chair

## ASSEMBLY INSTRUCTIONS

Please read the instructions carefully before beginning assembly. Ensure that you have all parts before assembly.

Place all parts on a soft and flat surface that is free of any debris to prevent scratches.

We're here to help - contact our Customer Service team by emailing [cs@ellaandross.com](mailto:cs@ellaandross.com) for questions or concerns.

PARTS INVENTORY		
ID	DESCRIPTION	QTY
<b>A</b>	SEAT 	1
<b>B</b>	BASE 	1
<b>C</b>	SCREW 	4
<b>D</b>	WASHER 	4
<b>E</b>	ALLEN KEY 	1

1

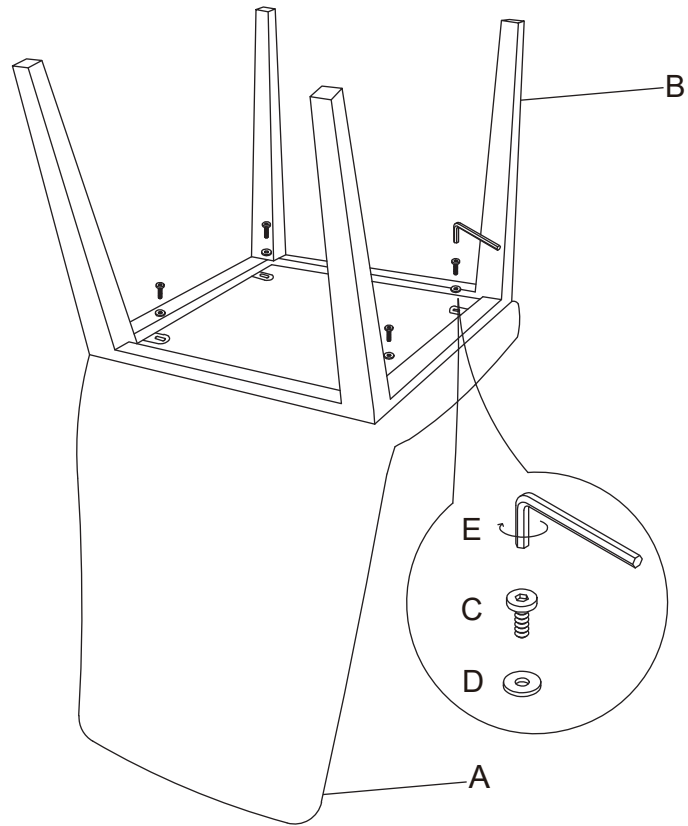

Align the base to the bottom of the seat.  
Tighten the screws up to 90%.

2

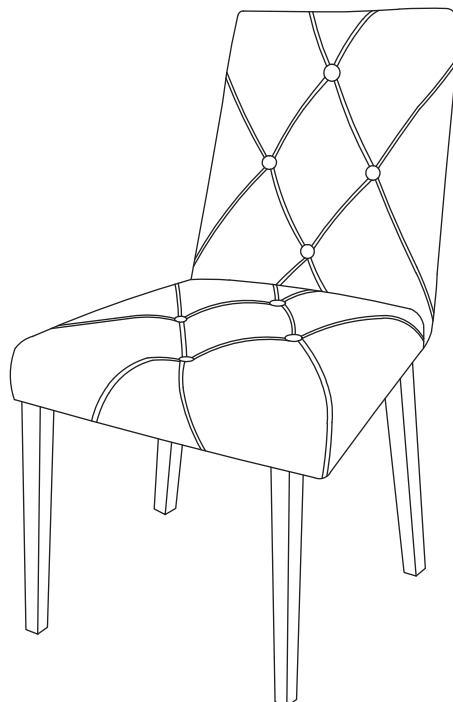

Place the chair upright and adjust the balance as needed.  
Tighten the screws completely to 100% once the chair is adjusted.  
Complete! Enjoy your new home addition.