

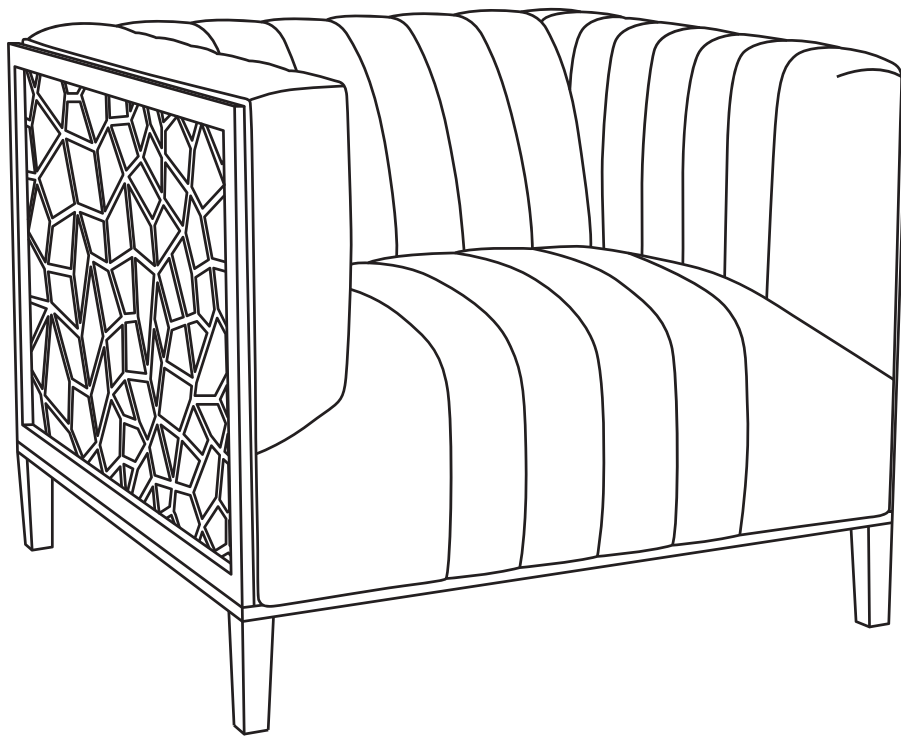

ELLA+ROSS

Assembly Instructions



CLARA





Accent Chair

ASSEMBLY INSTRUCTIONS

Please read the instructions carefully before beginning assembly. Ensure that you have all parts before assembly.

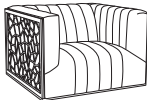
Place all parts on a soft and flat surface that is free of any debris to prevent scratches.

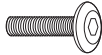
We're here to help - contact our Customer Service team by emailing cs@ellaandross.com for questions or concerns.

PARTS INVENTORY		
ID	DESCRIPTION	QTY
A	SEAT 	1
B	LEG 	4
C	SCREW 	8
D	WASHER 	8
E	ALLEN KEY 	1

1

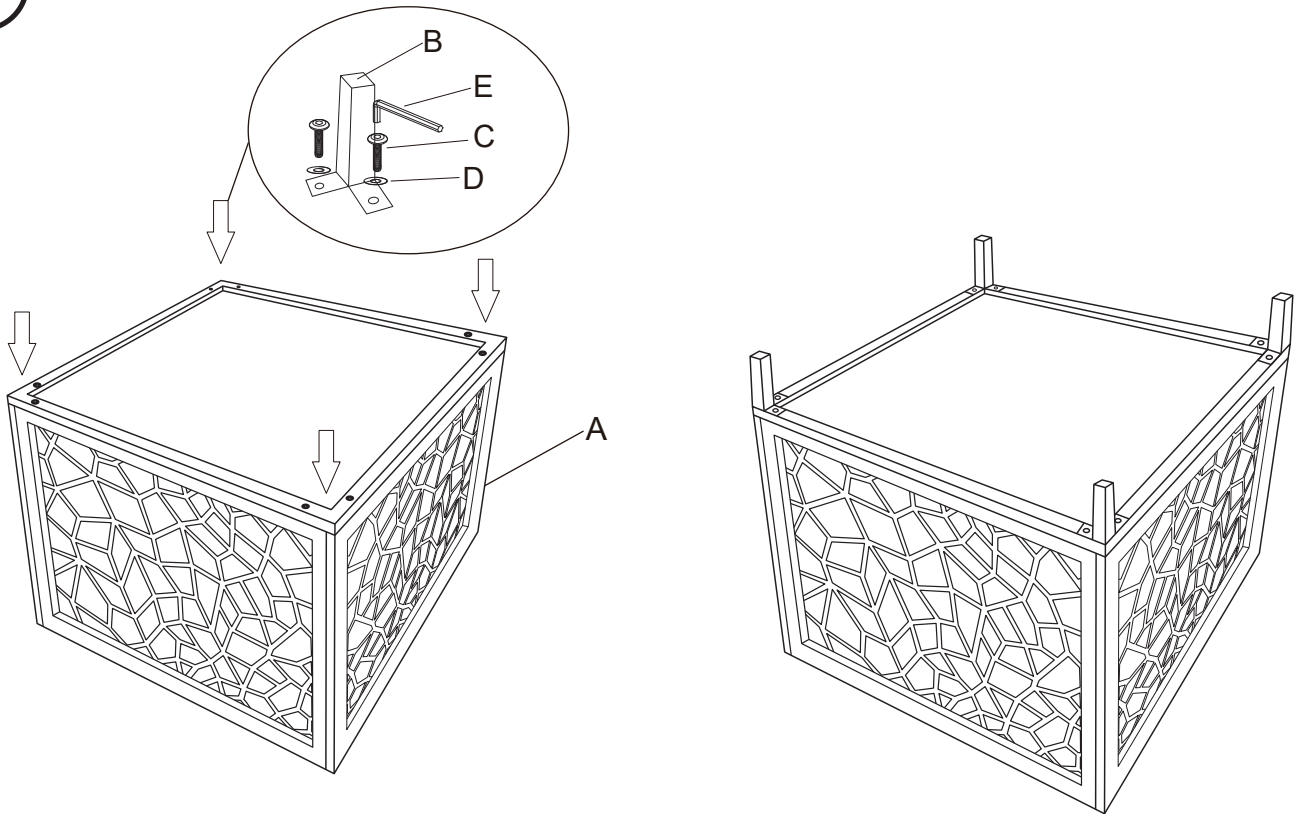

Place the leg screws into the holes of the chair.
Tighten the screws up to 90%.

2

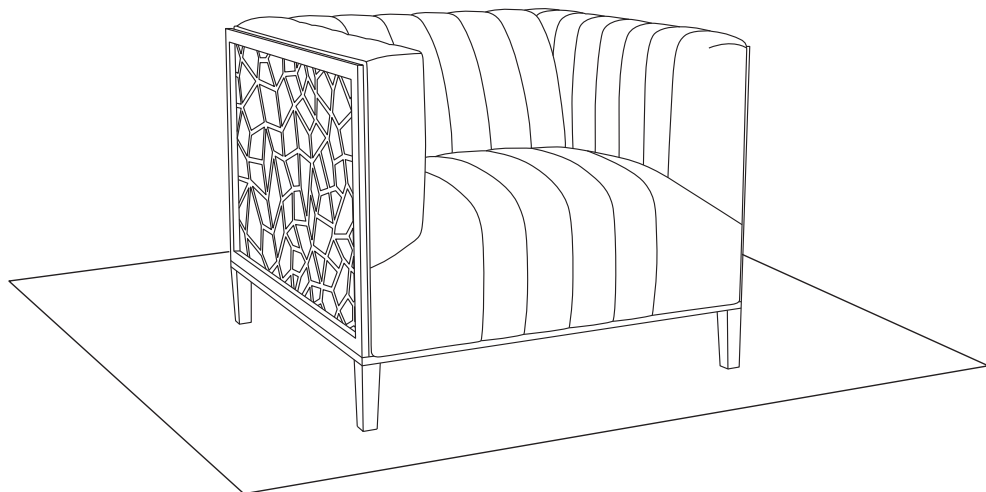

Place the chair upright and adjust the balance and legs as needed.
Tighten the screws completely to 100% once the chair is adjusted.
Complete! Enjoy your new home addition.